



ilalift

intelligent lift art

ilo *Grande*



ilo *Majesty*



ilo *Maxi*



YOUR **SMART**LIFT **SOLUTION**

www.ilalift.com

Certified
TÜV AUSTRIA
EN81-41:2010





4 mm CLEAR SOLID POLYCARBONATE CLADDING

PRODUCT CODE	CVL-SEN-1100	CVL-SEN-1300	CVL-SEN-1500	CVL-SEN-1700
STRUCTURAL OPENING	Ø 1100 MM	Ø 1300 mm	Ø 1500 mm	Ø 1700 mm
CABINET DIAMETER	Ø 800 MM	Ø 1000 MM	Ø 1200 MM	Ø 1400 MM
DOOR OPENING	600 X 2000 MM	600 X 2000 MM	750 X 2000 MM	900 X 2000 MM
CAPACITY	200 KG	300 KG	400 KG	500 KG
POWER SUPPLY	220V OR 380V-50 Hz	220V OR 380V-50 Hz	380 V-50 Hz	380 V- 50 Hz
MACHINE KW	3,7 KW - 3 Phase	3,7 KW - 3 Phase	5,5 KW - 3 Phase	6,8 KW - 3 Phase

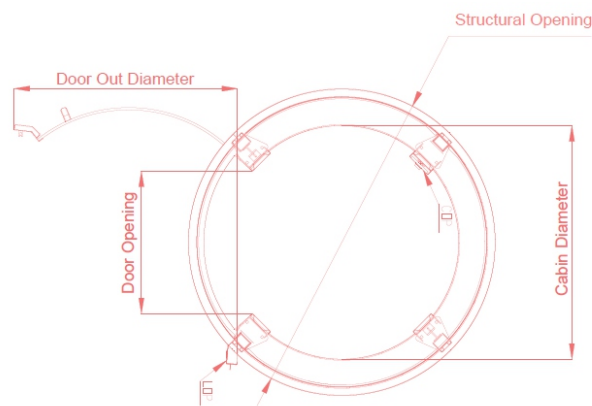

4X4MM CLEAR GLASS LAMINATED CLADDING

PRODUCT CODE	OVL-SEN-1000	OVL-SEN-1200	OVL-SEN-1400	OVL-SEN-1600
STRUCTURAL OPENING	1000 X1000 MM	1200 X 1200 MM	1400 X 1400 MM	1500 X 1500 MM
CABINET DIAMETER	700 X 700 MM	900 X900 MM	1100 X1100 MM	1200 X 1200 MM
DOOR OPENING	570 X 2000 MM	700 X 2000 MM	850 X 2000 MM	1000 X 2000 MM
CAPACITY	200 KG	300 KG	400 KG	500 KG
POWER SUPPLY	220V OR 380V-50 Hz	220V OR 380V-50 Hz	380 V-50 Hz	380 V- 50 Hz
MACHINE KW	3,7 KW - 3 Phase	3,7 KW - 3 Phase	5,5 KW - 3 Phase	6,8 KW - 3 Phase

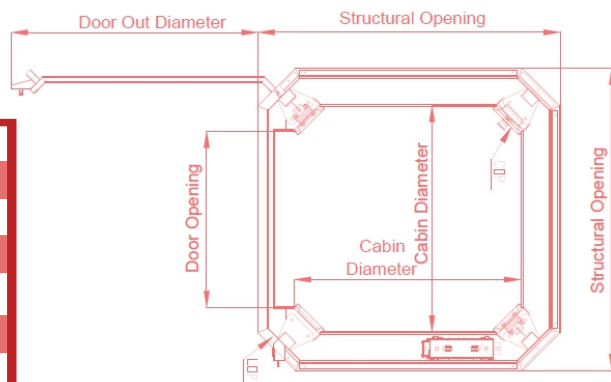

4X4MM CLEAR GLASS LAMINATED CLADDING

PRODUCT CODE	SVL-SEN-1300	SVL-SEN-1400	SVL-SEN-1500	SVL-SEN-1600
STRUCTURAL OPENING	1300 X1300 MM	1400 X 1400 MM	1500 X 1500 MM	1600 X 1600 MM
CABINET DIAMETER	1000 X 1000 MM	1100 X 1100 MM	1200 X 1200 MM	1300 X 1300 MM
DOOR OPENING	800 X 2000 MM	900 X 2000 MM	1000 X 2000 MM	1000 X 2000 MM
CAPACITY	200 KG	300 KG	400 KG	500 KG
POWER SUPPLY	220V OR 380V-50 Hz	220V OR 380V-50 Hz	380 V-50 Hz	380 V- 50 Hz
MACHINE KW	3,7 KW - 3 Phase	3,7 KW - 3 Phase	5,5 KW - 3 Phase	6,8 KW - 3 Phase

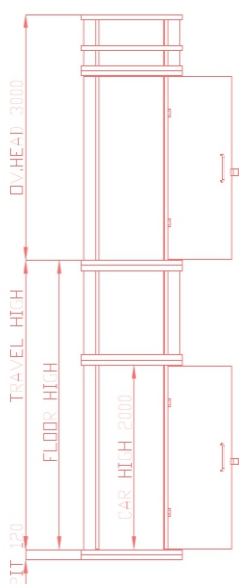
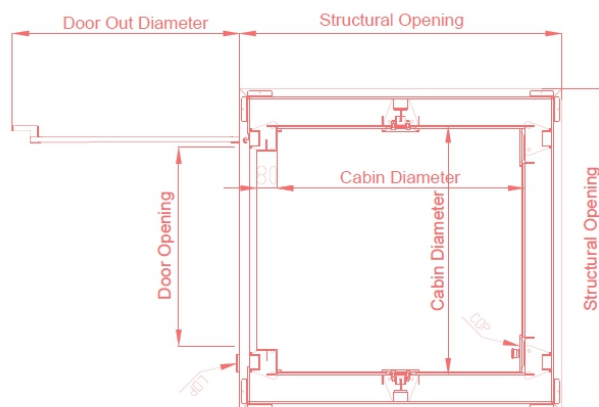

General Specifications

- Maximum Travel : 14 MT
- Maximum Levels : 5 Stops / 17.1 MT
- Pit Depth : 120 mm - No pit with optional short ramp
- Installation Place : Inside - Outside
- Drive Train : Winding Drum Machine with Encoder (Made in Italy)
- Machine Control : Preprogrammed variable frequency drive (Made in Turkey)
- Rope : 8 mm standard: Turkish quality, on request: German quality.
- Transmission : Ultra-low vibration, 3-stage, right-angle, helical-bevel drive.
- Noise Level : 54db ventilator OFF - 56db with ventilator ON.
- Encoder : FNC 50 H(*EC)
- Cabin Ceiling : LED Spot Light - Spot Light
- Cabin Operating Panel : Intercom - Alarm - Emergency Stop Button (GENEMEK brand made in Turkey)
- Overload Indication : Built in on COP
- Cabin Flooring : Pvc - Wood
- Cop : Intercom - alarm - fan - emergency stop button (COP-LOP made in Turkey)
- Cabinet Ceiling : Etched steel or wood with spot light.
- Shaft Construction : Profil
- Door Type : Swing manuel door and swing semi-automatic choice
- Door interlocks : Italian brand - (Made in Italy)





Color Options



Our ESP painting method reflects itself in a shiny surface, flexible & durable coating which is less liable to chip or peel. All used materials are appropriate for inside or outside use with no VOC content.

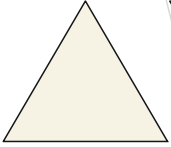

Ral 9001
Cream

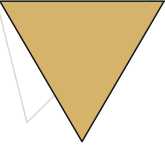

Ral 1004
Golden Yellow

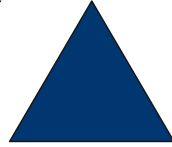

Ral 5002
Ultramarine Blue



Ral 9004
Signal Black

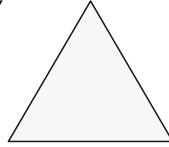

Ral 9003
Signal White

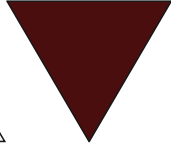

Ral 8012
Red Brown

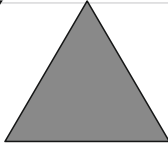

Ral 9007
Grey Aluminium

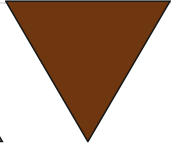

Ral 8003
Clay Brown

Stainless Steel Options

Alternatively we offer stainless steel covers in variant colors and cravings.

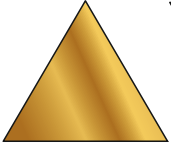

Mirror
Ti-Gold

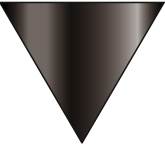

Mirror
Ti-Black

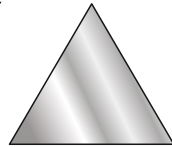

Mirror

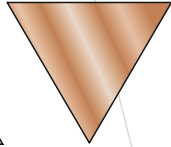

Mirror
Ti-Rose

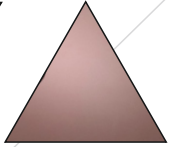

Mirror
Ti-Bronze



Hairline

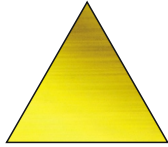

AF-Hairline
Ti-Gold



Hairline
Ti-rose



Ceiling and floor Option

Ceiling and floor types in different colors and textures



HG BEYAZ MERMER
C 1918

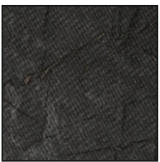

HG SIYAH GRANIT
C 1922

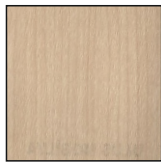

AKCA AGAC
C 1452



ALMAN ANTRASIT
C 1440

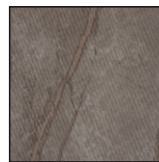

HG KAHVE GRANIT
C 1920



BEYAZ HUS
C 1439



HG YESIL GRANIT
C 1921

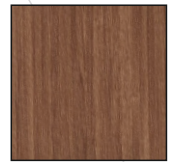

BAMBU
C 1454



MAT AYTAZI
C 1428

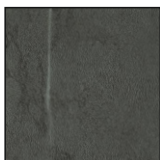

YESIL KAYAC
C 1831



BUTE GUMUS
C 1427



NATUREL SILVER
C 1479

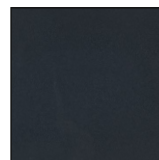

SATEN SIYAH
C 1453

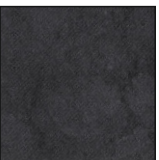

SIYAH GRANIT
C 1843

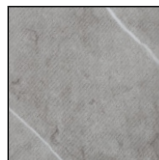

ACIK GRANIT
C 1841

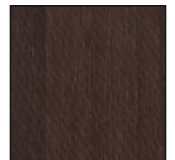

AMERIKAN CEVIZ
C 1641



8 LAYERS OF SAFETY

SAFETY

Photosell Sensors 1

This high quality light sensor will force the lift to stop immediately when passengers or objects approach the exit of the lift while in use.

2 Mechanical Guide Rails Brakes

Even if all the cables snapped, the elevator still would not fall to the bottom floor. Thanks to the passive, automatic, built-in braking system these brakes will lock in place whenever the elevator starts to fall faster than an allowed amount.

3 Overload Sensor

When the car is overloaded, the elevator won't move and will give a sign on the COP.

4 Limit & Emergency Stop Switches

These switches will assure stopping the car when the lift reaches or passes its final destination or in case of emergency.

5 Machine Brake Hand

In case of emergency this system allows the technician to free the car and make it descent to the closest down floor.

6 Magnetic Lock Switch

To ensure that the door of the elevator can open only if the car is available and the elevator is not in use.

7 Overspeed Governor

This device is specifically designed to stop the lift if it runs beyond the prescribed speed.

8 Rescuing System UPS with Support

This is a battery backup system that provides backup power when the regular power source fails or voltage drops to an unacceptable level. In that case, the battery mode is automatically turned on.

What Makes us Unique?

Smart Civil Work

This lift is an ideal solution to be installed on the exterior face of the building, in the lobby, or at a place where it can enhance the elevation and the 'look&feel' of the building. We introduce you to an electrical home elevator that requires no supporting wall, pit, or hydraulics vacuum systems. Just plug it into your domestic electrical socket and start moving up & down!



Minimal Maintenance

This is an electrical self-supporting elevator. No use of oil, vacuum systems, or counterweights. This means less maintenance and saves a lot of additional costs and time during the installation-process.



Plug & Play

These Elevators come as a semi-assembled unit just install, plug and play. No surprises!



Self Supported Structure

this elevators that does not require any supporting beam, column or walls. All you need is the space!



Panoramic View

The unique glassy sightseeing capsule enables the passengers to have eye contact with the surrounding area, even when the lift is in motion.



Green Elevator

This elevator is made of eco-friendly raw materials that are harmless when damaged. It requires the least amount of assembly and maintenance resources and consumes less energy when in use compared to the other traditional elevators.



Noise

you can count on a smooth moving system with no commotion.



Multiple Door Access



ilalift
intelligent lift art

Only Authorised Dealer in Turkey

Dudullu Org. İmes C306 No:6 34775 Ümraniye / İstanbul

Tel:+90 216 526 01 17

www.ilalift.com | info@ilalift.com

ARESFORTI
ELEVATOR

Factory Headquarters

Aydınlı Sb Mahallesi, Yelmen Caddesi, No: 5 Tuzla / İSTANBUL

Tel:+90 216 504 36 99

www.aresforti.com | sales@aresforti.com